

INSTALLATION MANUAL AND SAFETY INSTRUCTIONS

Rev.9

SOLVIS PHOTOVOLTAIC MODULES FAMILY



Table of Contents

Table of Contents	1
1. Introduction.....	1
1.1. Disclaimer of Liability	1
1.2. International Electrotechnical Commission (IEC) Listing Information	1
1.3. Limited Warranty	1
2. General Safety.....	2
2.1. Safety Precautions	2
2.2. Packing removal and temporary storage	2
3. Installation	3
3.1. General.....	3
3.2. Notes on Installation	3
3.3. Module Mounting	3
3.3.1. Site Considerations	3
3.3.2. Mounting Configurations	3
3.3.3. Permissible loads on the module	5
3.3.4. Wiring.....	7
3.4. General Wiring.....	7
3.5. Grounding.....	7
3.6. Series Connection	7
3.7. Parallel Connection	7
4. Maintenance	8
5. Specifications	9

1. Introduction

This manual provides information for SOLVIS photovoltaic (PV) modules.

Serial number: 1YYMM00001 (~99999) (Ex. 1130100004)

- 1 – production site (SOLVIS factory)
- YYMM : Production year and month
- 00001~99999 : Production number

This document is applicable to SOLVIS polycrystalline and monocrystalline photovoltaic modules.

Important! Read this instruction sheet in its entirety before installing, wiring or using this product in any way. Failure to comply with these instructions will invalidate SOLVIS Limited Warranty for PV module.

1.1. Disclaimer of Liability

The installation techniques, handling and use of this product are beyond company control. Therefore, SOLVIS does not assume responsibility for loss, damage or expense resulting from improper installation, handling or use.

1.2. International Electrotechnical Commission (IEC) Listing Information

This product meets all requirements listed by IEC 61215 edition 2 for terrestrial PV modules. The IEC standard covers flat-plate PV modules and panels intended for installation on buildings and those intended to be freestanding. This product is not intended for use where artificially concentrated sunlight is applied to the module.

1.3. Limited Warranty

Limited warranty on SOLVIS PV modules is defined in separate document “SOLVIS Limited Product Warranty for PV modules”. Last version of this document, can be downloaded from SOLVIS web, on address:

<http://www.solvis.hr/downloads/warranty-and-manuals/>.

2. General Safety

2.1. Safety Precautions

Danger! PV modules are sources of voltage when exposed to light. Module interconnects pass direct current (DC) when the module is under load. Do not connect or disconnect modules when they are under load! Direct current can arc across gaps and may cause injury or death if improper connection or disconnection is made, or if contact is made with module leads that are frayed or torn.

Before installing this device, read all safety instructions in this manual!

- Cover all modules in the PV array with an opaque material before making or breaking electrical connections.
- All installations must be performed in compliance with all applicable regional and local codes.
- Do not attempt to repair any part of the module.
- Do not try to disassemble the module.
- Do not use modules that are damaged (e.g.: front glass is broken or back sheet is torn)
- Do not open the junction box on the back side of the module.
- Contact your module supplier if maintenance is necessary.
- Installation should be performed only by authorized personnel.
- Use only equipment, connectors, wiring and supporting constructions designed for use in photovoltaic systems.
- Remove all metallic jewelry prior to installing this product to reduce the chance of accidental exposure to live circuits.
- Use insulated installation tools to reduce risk of electrical shock.
- Do not stand on, drop, scratch or allow objects to fall on modules.
- To avoid damage to the backsheet, do not scratch or hit the backsheet.
- Do not drill holes in the frame, as this can compromise the frame strength and cause corrosion of the frame.
- Do not scratch the frame as this may remove the anodized coating of the frame and cause corrosion of the frame.
- Do not use junction box or connecting wires for transportation help or for holding the module.
- Do not treat the back side of modules with paint, glue or sharp objects.
- If the front glass is broken or the back sheet is torn, contact with any module surface or module frame can cause electric shock.
- Do not install or handle the modules when they are wet or during periods of high wind.
- SOLVIS SV60 modules have been qualified for Application Class A
- Save these instructions for later reference in an easy reachable place.

2.2. Packing removal and temporary storage

- Modules must be stored in dry and ventilated spaces.
- Leave modules unpacked in their original packing until you are ready to install them.
- Carry the modules with both hands.
- Do not put weight on the modules.
- Do not remove any identification labels from the modules.
- If storing uninstalled modules outdoors for any period of time, always cover the modules and ensure that the glass faces down to stop water from collecting inside the module and on top of the glass.

3. Installation

3.1. General

Before install and operate, this manual must be well understood.

3.2. Notes on Installation

A gap between PV module frame and installation object is necessary for cooling air circulation. Do not seal this gap. The recommended standoff height is minimum 10 cm (4 inch).

3.3. Module Mounting

SOLVIS Limited Warranty for PV Modules is contingent upon modules being mounted in accordance with the requirements described in this section.

3.3.1. Site Considerations

SOLVIS modules should be mounted in locations that meet the following requirements:

Operating Temperature: All SOLVIS modules must be mounted in environments that ensure operation within the following maximum and minimum operating temperatures:

Maximum Operating Temperature: + 85°C

Minimum Operating Temperature: - 40°C

Care should be taken to provide adequate ventilation behind the modules, especially in hot environments.

Design Strength: SOLVIS modules are designed to meet a maximum positive (or upward, e.g. wind) and negative (or downward, e.g. static load) load of 2400 Pa (Pascal; 2400 kg/m²) and snow load of 5400 Pa if fixing points are on position A2, like specified in section 3.3.3. For other allowed loads, see table in section 3.3.3.

When mounting modules in snow prone or high wind environments, special care should be taken to mount the modules in a manner that provides sufficient design strength while meeting local code requirements.

Excluded Operating Environments: Certain operating environments are not recommended for specific SOLVIS modules and are excluded from the SOLVIS Limited Warranty for these modules.

3.3.2. Mounting Configurations

Modules may be mounted at any angle from horizontal to vertical with exclusions mentioned in this manual. Select the appropriate orientation to maximize sunlight exposure. Specific information on module dimension and the location of mounting and grounding holes is provided below (Figure 2). We recommend that PV modules are mounted at a minimum tilt angle of 6° with respect to the horizon, in order to facilitate the self-cleaning of their front glass from dirt during ordinary raining.

In order to prevent water from entering the junction box, which could present a safety hazard, modules should not be mounted in manner that the front/top glass faces downward (e.g. on a tracking structure that positions the module with the junction box facing skyward during sleep mode).

Clearance between the module frames and structure or ground is required to prevent wiring damage and allow air to circulate behind the module.

When installed on a roof, the module shall be mounted over a fire-resistant roof covering rated for the application.

The module is only IEC listed for use when its factory frame is fully intact. Do not remove or alter the module frame. Creating additional mounting holes may damage the module and reduce the strength of the frame.

Modules may be mounted using the following methods only:

- 1) **Frame Holes:** Secure the module to the structure using the factory mounting holes. Four M6 (1/4") stainless steel bolts, with nuts washers, and lock washers are recommended per module (*Figure 1.*). Position of mounting holes for module types SV60 and SV72 can be seen on figure 2, for other type of modules, please check relevant datasheet.

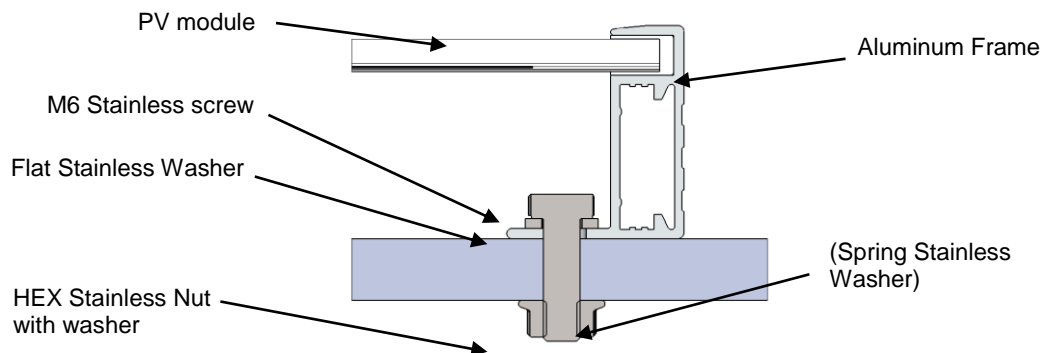

Figure 1. Screw fitting (for illustration only)

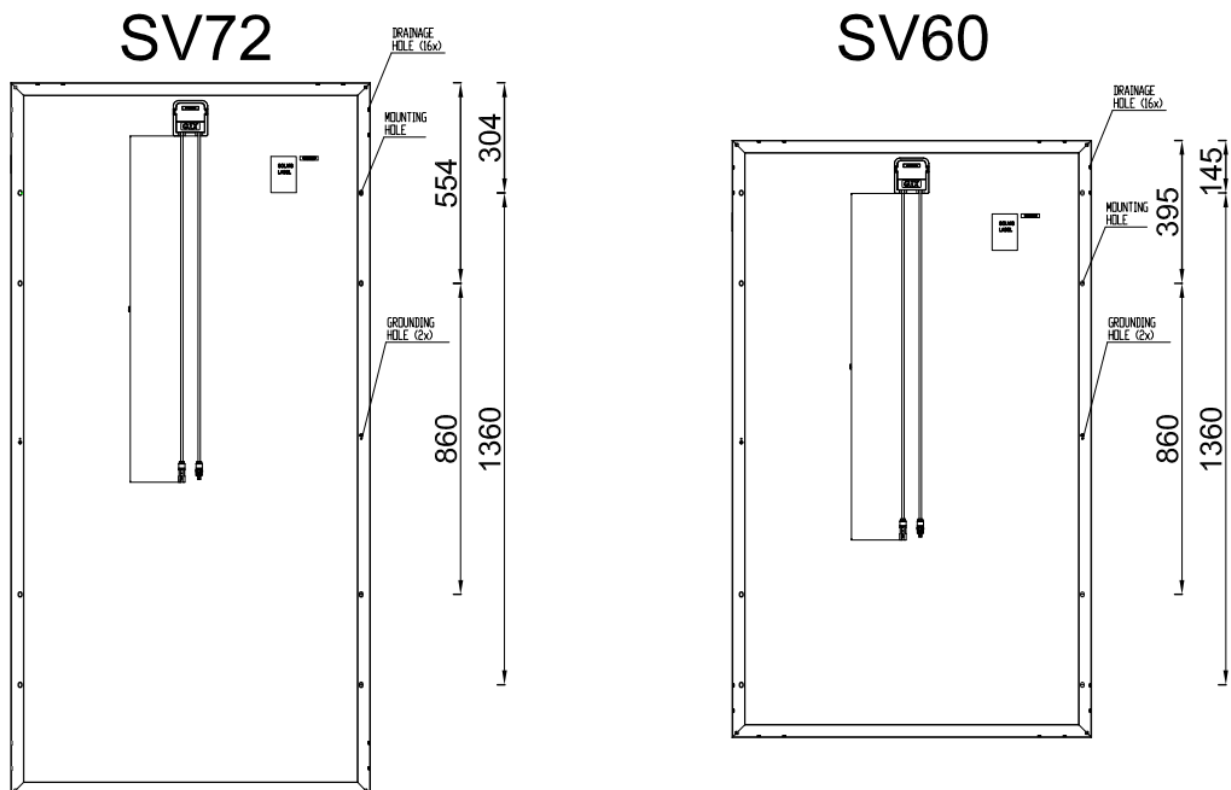

Figure 2. Positions of mounting holes, SV72 and SV60

- 2) **Pressure Clamps or Clips:** Mount the module with the clips on the side frame of the module. The side frames are attached to the longer or shorter sides of the module. Clamps should always hold the modules with its entire length, ie it is not allowed to mount the clamps at angle or outside of module frame. Installers should ensure that the clamps are of sufficient strength to allow for the maximum design pressure of the module. Clips and clamps are not provided by SOLVIS.

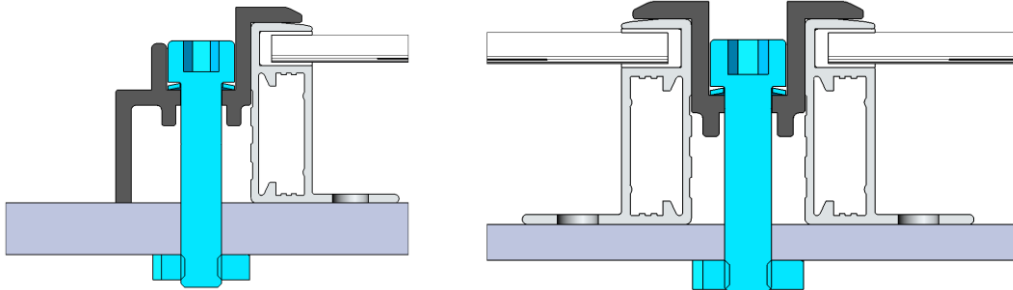

Figure 3. Clamp fitting (for illustration only)

- 2) **End Mount:** End mounting is the capture mounting of the length of the module's end frame to a supporting rail. The end frames can be on the shorter or on the longer sides of the module. Modules should not slide of the end mount and distance between modules must be secured.

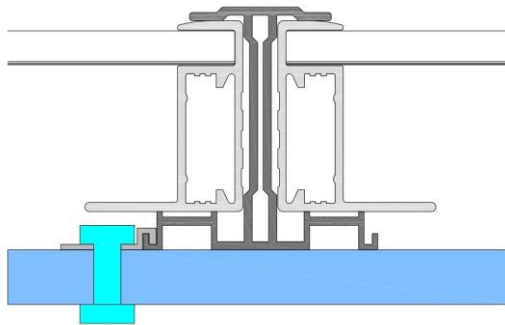

Figure 4. Mounting of the modules using end mounts (for illustration only)

Dimensions of SOLVIS modules based on which dimensions of end mounts are selected can be seen in table 2.

3.3.3. Permissible loads on the module

Allowed load on the module depends on the position of the fixing pint. Position of the fixing point is defined as a distance from the edge of the module. Table with values of allowed loads depending on the position of fixing point can be seen in table 1

Table 1. – Loads of the module depending on the position of fixing point

Position	Load	
	Pressure [Pa]	Suction [Pa]
A1	3500	2000
A2	5400	2400
A3	3500	2000
A4	3500	2000
Long side of the module in end mount	5400	2400
Short side of the module in end mount	3500	2000

**In case of special mounting conditions and loads for certain locations, please consult the manufacturer*

Solvis always recommends to set fixing point on position **A2**. Fixing modules out of labeled position module warranty voids. Positions A1, A2, A3 i A4 and their distances from edge of the module can be seen on figures 5 and 6.

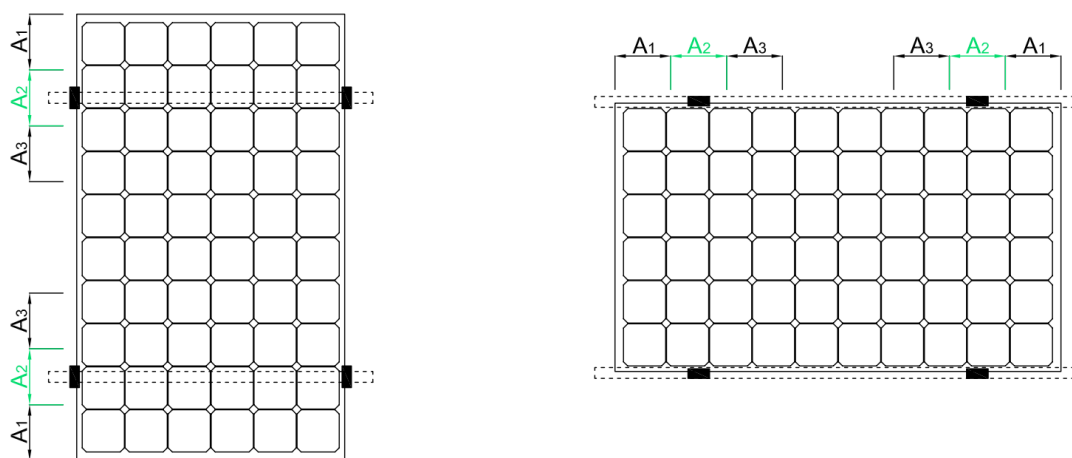

Figure 5. Mounting on longer side of the module

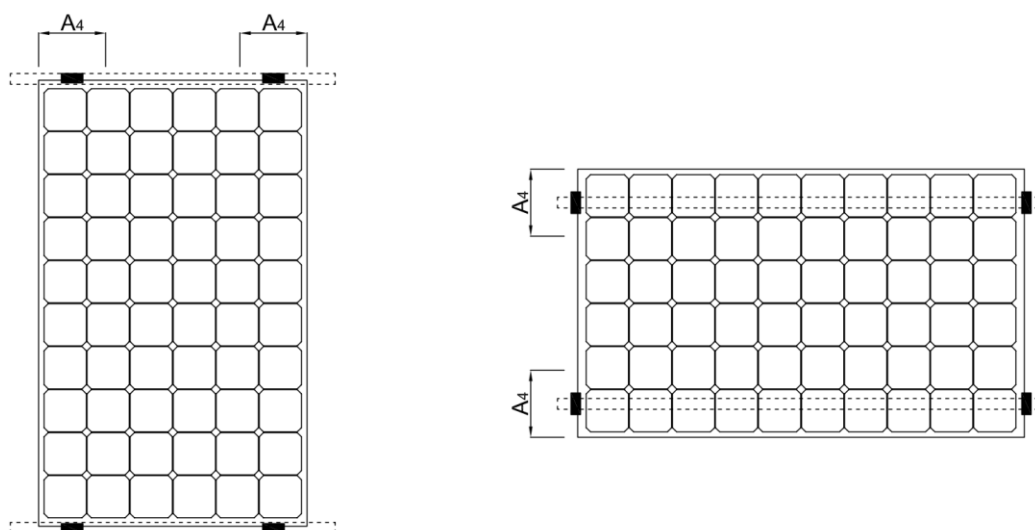

Figure 6. Mounting on short side of the module

Tablica 2. – distance of fixing point from edge of the module

PV module	Module dimensions [mm]			Distance from edge of the module [mm]			
	L	W	D	A1	A2	A3	A4
SV72	1962	992	40	0 - 245	245 - 491	491 - 736	0 - 248
SV60	1650	992	40	0 - 206	206 - 413	413 - 619	0 - 248
SV54	1491	992	40	0 - 186	186 - 373	373 - 559	0 - 248
SV48	1332	992	40	0 - 167	167 - 333	333 - 500	0 - 248
SV36	1014	992	40	0 - 127	127 - 254	254 - 380	0 - 248
SV72(5)	1574	812	40	0 - 197	197 - 394	394 - 590	0 - 203
SV36(5)	844	812	40	0 - 106	106 - 211	211 - 317	0 - 203

*Manufacturer holds the right to change module dimensions without prior announcement, please use most recent version of this document from manufacturer website

3.3.4. Wiring

To achieve the desired electrical output modules can be connected in series and/or parallel as long as certain conditions are met. Use only the same type of modules in combined source circuit.

3.4. General Wiring

SOLVIS recommends that all wiring be double insulated with a minimum rating of 90 °C. All wiring should use flexible copper (Cu) conductors. Minimum size should be determined by the applicable codes. We recommend a size not less than 4 mm². The insulation type should be appropriate for the type of installation method used and must meet IEC 61730 and Safety Class II requirements.

3.5. Grounding

All module frames and mounting racks must be properly grounded in accordance with appropriate respective national electrical code. Proper grounding is achieved by bonding the module frames and all metallic structural members together continuously using a suitable grounding conductor. Grounding conductor or strap may be copper, copper alloy, or other material acceptable for use as an electrical conductor per respective National Electrical Codes. The grounding conductor must then make a connection to earth using a suitable earth ground electrode.

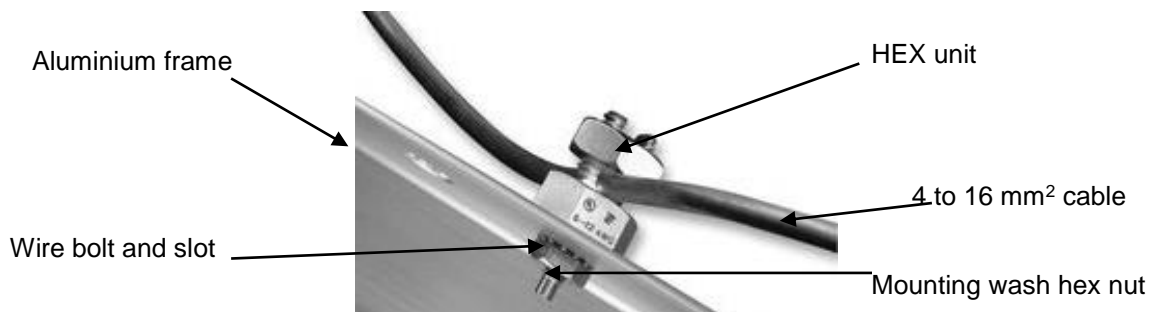

Figure 6. Module frame grounding

To ensure optimal performance of SOLVIS modules in combination with galvanically isolated inverters, it is recommended to ground negative (-) polarity of the PV array. While using modules in combination with transformerless inverter, both poles of the PV array (positive(+) and negative(-)) must remain ungrounded, unless specifically allowed by inverter manufacturer.

3.6. Series Connection

Modules may be wired in series to produce the desired voltage output. The maximum number of modules connected in series are defined by sum of single module $V_{oc} \cdot 1,25$ up to the maximum system voltage. Overcurrent protection rating is calculated by module $I_{sc} \cdot 1,56$.

Do not exceed the maximum system voltage!

3.7. Parallel Connection

Modules may be combined in parallel to produce the desired current output. The maximum number of modules in parallel connection depends on inverter's capacity. Every series string or module must be fused prior to combining with other strings. Bypass diodes are factory installed in the modules. Please refer to applicable regional and local codes and also inverter producer for additional fusing requirements and limitations on the maximum number of modules in parallel.

4. Maintenance

Inspect all modules annually for safe electrical connections, sound mechanical connection and freedom from corrosion. Glass of PV-modules can be washed with plenty of clean water and Soft paper towels, soft brushes, soft cloths or tissues. Once cleaned, the glass should be rinsed with clean water and carefully wiped with a soft cloth.

Before washing the glass with AR coating make sure to remove all residues and particles that could scratch the surface of the glass (grains of sand, glass splinters, iron oxides, etc...)

Make sure that cloths, brushes and other tools are clean and in good conditions at all times during cleaning. Abrasive powders, razor blades, scrub sponges and pads must not be used on solar glasses.

Use of such materials will invalidate the product warranty. Modules that are mounted flat (0° tilt angle) should be cleaned more often, as they will not self-clean as effectively as modules mounted at a 15° tilt or greater. We recommend that PV modules are mounted at a minimum tilt angle of 6° with respect to the horizon, in order to facilitate the self-cleaning of their front glass from dirt during ordinary raining.

5. Specifications

Module electrical ratings are measured under Standard Test Conditions (STC) of 1000 W/m² irradiance with AM 1.5 spectrum and cell temperature of 25 °C. Electrical characteristics for specific SOLVIS PV modules are located on the product label and product datasheet.

Under normal conditions, a photovoltaic module is likely to experience conditions that produce more current and/or voltage than reported at standard test conditions. Sunny and cool weather and reflection from snow or water can increase current and power output. Accordingly, the values of voltage should be multiplied by factor 1,25 and values of current by factor 1,56 when determining component voltage ratings, conductor current ratings, fuse sizes, and size of controls connected to the PV output.

List of applicable series of solar modules:

Polycrystalline

SV72 YYY family
 SV60 YYY family
 SV54 YYY family
 SV48 YYY family
 SV36 YYY family

SV72 D YYY family
 SV60 D YYY family
 SV54 D YYY family
 SV48 D YYY family
 SV36 D YYY family

Monocrystalline

SV72 E YYY family
 SV60 E YYY family
 SV54 E YYY family
 SV48 E YYY family
 SV36 E YYY family
 SV36(5) E YYY family
 SV72(5) E YYY family

SV72 ED YYY family
 SV60 ED YYY family
 SV54 ED YYY family
 SV48 ED YYY family
 SV36 ED YYY family
 SV36(5) ED YYY family
 SV72(5) ED YYY family